

SUN2000-100KTL-M0 Smart PV Controller



Smart

Smart I-V Curve Diagnosis supported



Efficient

Max. efficiency 98.8%



Safe

Fuse free design



Reliable

Type II surge arresters for DC & AC

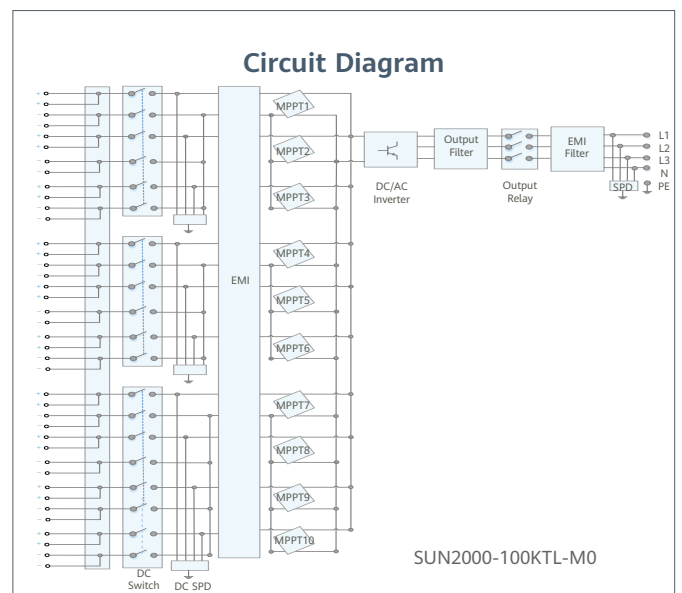
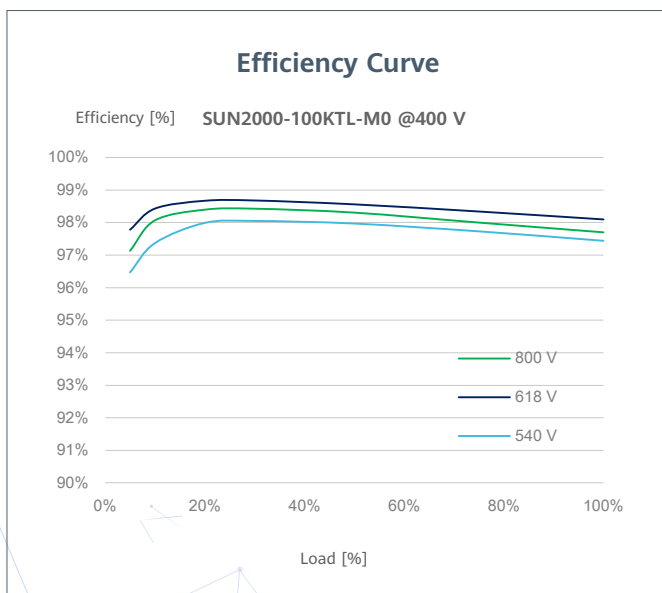

Technical Specification	SUN2000-100KTL-M0
Efficiency	
Max. Efficiency	98.8% @480 V; 98.6% @380 V/400 V
European Efficiency	98.6% @480 V; 98.4% @380 V/400 V
Input	
Max. Input Voltage	1,100 V
Max. Current per MPPT	26 A
Max. Short Circuit Current per MPPT	40 A
Start Voltage	200 V
MPPT Operating Voltage Range	200 V ~ 1,000 V
Rated Input Voltage	570 V @380 V; 600 V @400 V; 720 V @480 V
Number of Inputs	20
Number of MPP Trackers	10
Output	
Rated AC Active Power	100,000 W (380 V / 400 V / 480 V @40°C)
Max. AC Apparent Power	110,000 VA
Max. AC Active Power (cosφ=1)	110,000 W
Rated Output Voltage	220 V / 230 V, default 3W + N + PE; 380 V / 400 V / 480 V, 3W + PE
Rated AC Grid Frequency	50 Hz / 60 Hz
Rated Output Current	152.0 A @380 V; 144.4 A @400 V; 120.3 A @480 V
Max. Output Current	168.8 A @380 V; 160.4 A @400 V; 133.7 A @480 V
Adjustable Power Factor Range	0.8 LG ... 0.8 LD
Max. Total Harmonic Distortion	<3%
Protection	
Input-side Disconnection Device	Yes
Anti-islanding Protection	Yes
AC Overcurrent Protection	Yes
DC Reverse-polarity Protection	Yes
PV-array String Fault Monitoring	Yes
DC Surge Arrester	Type II
AC Surge Arrester	Type II
DC Insulation Resistance Detection	Yes
Residual Current Monitoring Unit	Yes
Communication	
Display	LED Indicators, APP
RS485	Yes
USB	Yes
MBUS	Yes (isolation transformer required)
General Data	
Dimensions (W x H x D)	1,035 x 700 x 365mm (40.7 x 27.6x 14.4 inch)
Weight (with mounting plate)	90 kg (187.4 lb.)
Operating Temperature Range	-25°C ~ 60°C (-13°F ~ 140°F)
Cooling Method	Smart Air Cooling
Max. Operating Altitude	4,000 m (13,123 ft.)
Relative Humidity	0 ~ 100%
DC Connector	Staubli MC4
AC Connector	Waterproof Connector + OT/DT Terminal
Protection Degree	IP66
Topology	Transformerless
Night Time Power Consumption	≤ 3.5 W
Standard Compliance (more available upon request)	
Safety	EN 62109-1/-2, IEC 62109-1/-2, IEC 62116
Grid Connection Standards	EN 50530, IEC 61727, IEC 60068, IEC 61683